

**JBL**

**HOME THEATER  
IN-WALL SERIES**

HTI88

**OWNER'S GUIDE**

# THANK YOU FOR CHOOSING JBL

For more than 50 years, JBL has been involved in every aspect of music and film recording and reproduction, from live performances to monitoring the recordings you play in your home, car or office.

We're confident that the JBL loudspeaker you have chosen will provide every note of enjoyment that you expect – and that when you think about purchasing additional audio equipment for your home, car or office, you will once again choose JBL.

Please take a moment to register your product on our Web site at [www.jbl.com](http://www.jbl.com). It enables us to keep you posted on our latest advancements, and helps us to better understand our customers and build products that meet their needs and expectations.

JBL Consumer Products

## INCLUDED

### HT188

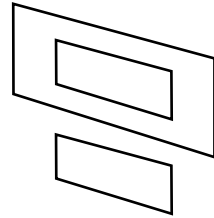
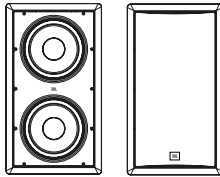
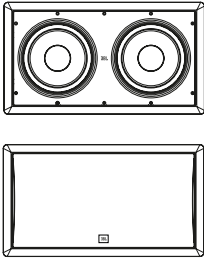

Template and Paint shield.

One loudspeaker with grille. Logo to be attached to grille depending on vertical or horizontal installation.

## SPEAKER PLACEMENT

Low-frequency sounds are normally omnidirectional, meaning the listener can't tell where they are generated from. However, frequencies between 75Hz and 150Hz can be localized, especially at higher volume levels. Positioning your subwoofer as recommended will provide the most natural soundstage and imaging from your loudspeaker system.

It is generally recommended that you install your HTI88 in-wall subwoofer along the same wall as the front loudspeakers. The HTI88 subwoofer is not video-shielded and should not be placed near a video display. Installing the HTI88 near a corner will tend to maximize low-frequency output. Be cautious when installing in a corner, to avoid a "boomy" sound. Also take into consideration any unusual features of the room, such as an alcove, which may tend to create a localized node that may affect bass response in that area of the room.

It is generally recommended that the speaker be installed so that the bottom of the speaker is approximately 12" from the floor. This is to help with the low-frequency loading (bass reinforcement). This also helps hide the speaker in a less visible place. In special circumstances it is acceptable to install the speaker at any height on a wall.

Remember that these are just guidelines. Since every listening room is different, JBL strongly recommends experimenting with the positioning of your subwoofer prior to cutting the wall to obtain the most pleasing results in your room. One technique that can help you find the ideal subwoofer location is to temporarily borrow a stand-alone subwoofer and place it near the main listening location. Then move around the room and determine where you hear the most pleasing bass performance. This would then be the ideal location for the subwoofer.

When using two HTI88 in-wall subwoofers, you may need to be concerned about phase, as the sound waves may cancel each other out. If bass response seems low, try inverting the polarity on one subwoofer – i.e., connect the (+) terminal on the amplifier to the (-) terminal on the speaker, and the (-) terminal on the amplifier to the (+) terminal on the speaker.

# SPEAKER CONNECTIONS

## CONNECTION TIPS

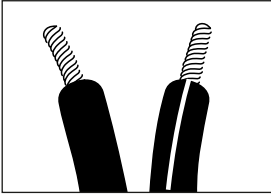

Speakers and electronics have corresponding (+) and (-) terminals. Most manufacturers of speakers and electronics, including JBL, use red to denote the (+) terminal and black for the (-) terminal. It is important to connect both speakers identically: (+) on the speaker to (+) on the amplifier and (-) on the speaker to (-) on the amplifier. Wiring “out of phase” results in thin sound, weak bass and a poor stereo image. With the advent of multi-channel surround sound systems, connecting all of the

speakers in your system with the correct polarity remains equally important in order to preserve the proper ambience and directionality of the program material.

If two HTI88 subwoofers are used, the wires for both speakers should be the same length. If one speaker is placed closer to the amplifier than the other, hide the excess wire behind the wall. If bass response seems low, there may be a phase problem, with the sound waves from the two subwoofers canceling each other out. If bass response seems low, try inverting the polarity on one subwoofer – i.e., connect the (+) terminal on the amplifier to the (-) terminal on the speaker, and the (-) terminal on the amplifier to the (+) terminal on the speaker.

To use the spring-clip-type terminals on the HTI88 loud-speaker, press the colored tab and insert the bare end of the wire into the hole. Release the tab and gently tug the wire to ensure that it is secure.

To use the push-type terminals on the connections panel supplied with the optional HTI88BB “back box” enclosure, depress the colored cap until the pass-through hole in the binding post is revealed. While holding the cap down, insert the bare end of the wire, or a banana plug, into the pass-through hole. Release the cap and tug gently on the wire to ensure that it is secure.

Since the HTI88 is a passive loudspeaker, only speaker-level connections are available. Depending on whether you are using a dedicated subwoofer

### Connection Method #1, Using One HTI88 (Remove Shorting Straps)

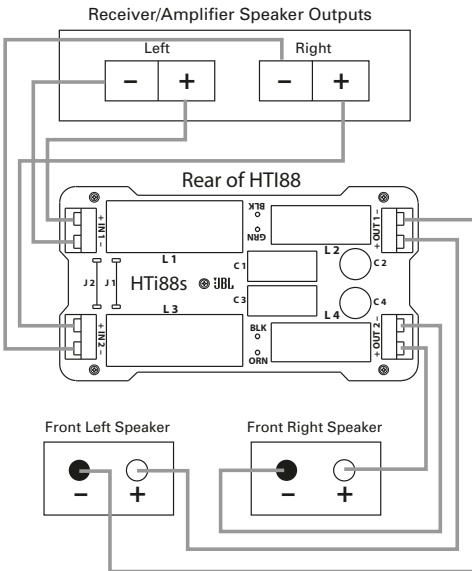

### Wire Length Recommended Size

Up to 20 ft.	16-gauge
Up to 30 ft.	12-gauge
Greater than 30 ft.	10-gauge

### Connection Method #1, Using One HTI88 With Back Box (Remove Shorting Straps)

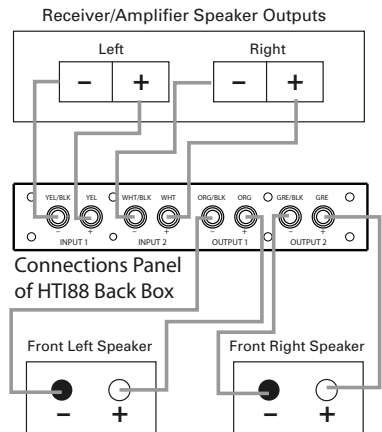

amplifier or your main receiver/ amplifier to power the HTI88, select one of the two connection methods that follow.

**Connection Method #1**

Use this method when you are using the HTI88 with your main receiver/amplifier. Connect the main left and right speaker-level outputs on your receiver/ amplifier to the Input 1 (for left

channel) and Input 2 (for right channel) connectors on the HTI88 loudspeaker or connection panel. Connect the Output 1 terminals to the corresponding terminals on your front left speaker, and the Output 2 terminals to the corresponding terminals on your front right speaker.

You may wish to mount the HTI88 horizontally to preserve

the stereo image of the left and right low frequencies.

The HTI88's onboard cross-over feeds the low-passed signal (2nd order at 100Hz) to the HTI88 subwoofers, and the high-passed signal to the speaker-level outputs for connection to the satellite speakers.

**Connection Method #1, Using Two HTI88 Loudspeakers (Use Shorting Straps)**

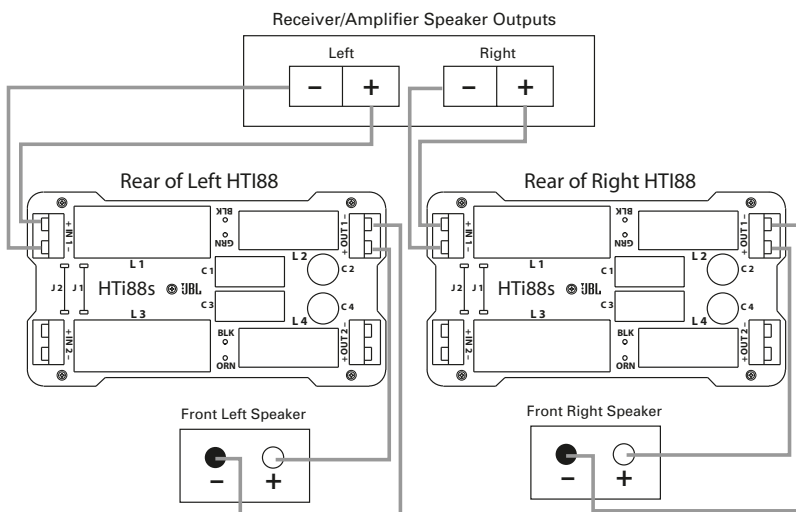

**Connection Method #1, Using Two HTI88 Loudspeakers With Back Boxes (Use Shorting Straps)**

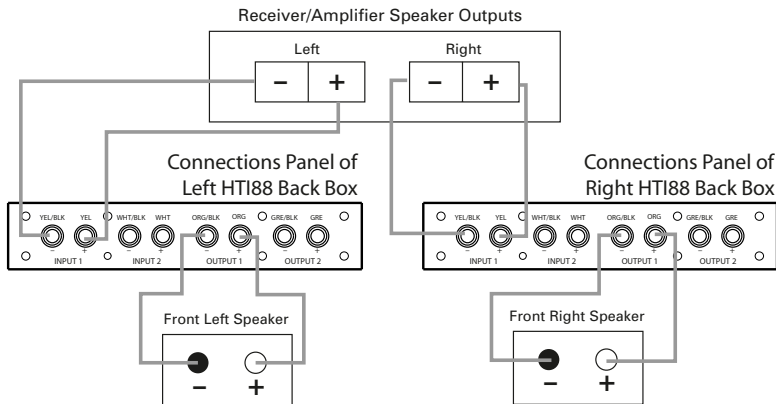

**Note:** When using Connection Method #1 with only one HTI88, the shorting straps must be removed.

If you are using two HTI88 subwoofers, connect the left speaker outputs on your receiver/amplifier to Input 1 on one subwoofer (or the connections panel on its back box), and the right speaker outputs on your receiver/amplifier to Input 1 on the second subwoofer (or the connections panel on its back box). Then connect Output 1 from the left-channel subwoofer to the inputs on your main left speaker, and Output 1 from the right-channel subwoofer to the inputs on your main right speaker. When using the HTI88 in this mono mode, you should not remove the shorting straps.

### Connection Method #2

Use this method when you are using the HTI88 with a dedicated subwoofer amplifier. Connect your main receiver/processor's line-level subwoofer output to the line-level input on your subwoofer amplifier. Connect the speaker terminals on your subwoofer amplifier to either Input 1 or Input 2. If your amplifier has stereo outputs, you may connect one channel to each of Inputs 1 and 2. However, you must remove the shorting straps when using stereo mode. Alternatively, you may connect each channel to a separate HTI88. When using only one input on an individual HTI88, you should leave the shorting bars in place.

**Note:** The built-in network on the HTI88 is a 2nd-order low-pass filter, crossed over at 100Hz. This filter is always active. Although the subwoofer or LFE output on your receiver/processor may already be crossed over, the HTI88's network will not interfere with the

higher-order processing that is occurring at the preamp stage.

### Using the HTI88BB Back Box

Whichever connection method you choose, if you are installing the HTI88BB back box, you will need to connect all of the eight wires coming out of the bottom of the back box to the appropriate terminals on the loudspeaker. The wires are color-coded as follows:

INPUT 1 (-): Yellow with black stripe

INPUT 1 (+): Solid yellow

INPUT 2 (-): White with black stripe

INPUT 2 (+): Solid white

OUTPUT 1 (-): Orange with black stripe

OUTPUT 1 (+): Solid orange

OUTPUT 2 (-): Green with black stripe

OUTPUT 2 (+): Solid green

### Connection Method #2, Using One HTI88 in Mono Mode (Use Shorting Straps)

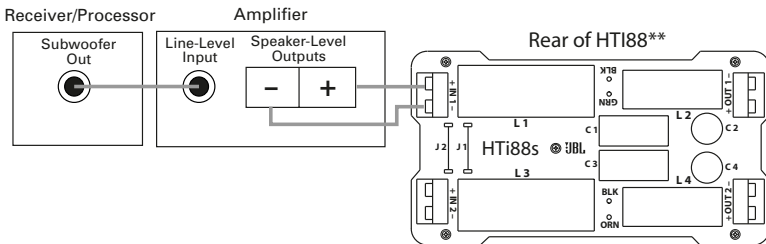

**Connection Method #2, Using One HTI88 in Stereo Mode (Remove Shorting Straps)**

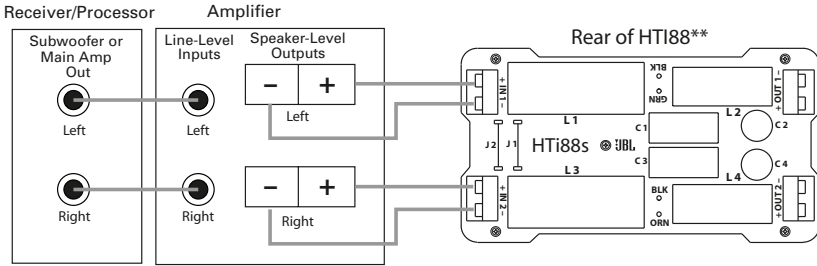

\*\* Use corresponding inputs on HTI88BB connections panel when installed with back box.

**Connection Method #2, Using Two HTI88 Loudspeakers With Back Boxes (Use Shorting Straps)**

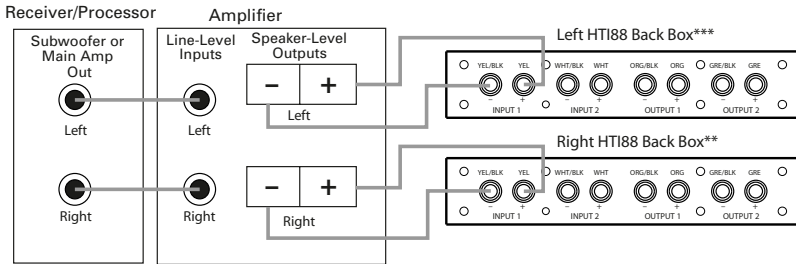

\*\*\* Use corresponding inputs on rear of HTI88 speaker when installed without back box.

# INSTALLATION

The JBL HTI Series in-wall speakers were designed to be easily installed. However, if you are unsure of your ability to properly install these loudspeakers, please contact your dealer or a qualified installer.

## Tools Needed

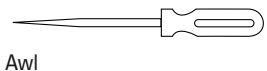
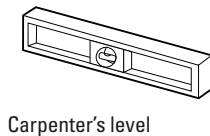
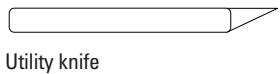
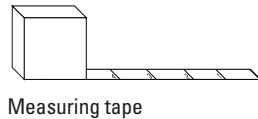
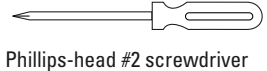

# EXISTING CONSTRUCTION

## HT188

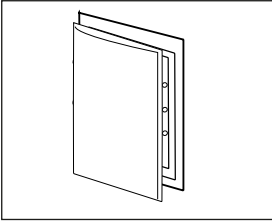

The grille is packed separately from the speaker. If at some later date you wish to remove the grille from the speaker, to avoid scratching the grille or baffle you may unfold a paper clip, insert the straight end through one of the holes in the grille, and gently pull up.

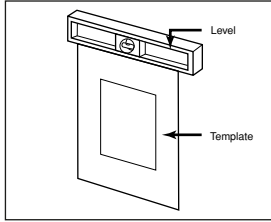

Determine the correct speaker location.

### Notes:

- Use the cardboard template when cutting the drywall. Although the HT188 may be oriented either horizontally or vertically, the installation procedure is the same.
- Please be aware the template is slightly oversized to allow for some margin of error when cutting with the drywall saw – there should be no need to allow for further margin of error as this may risk the integrity of the installation.

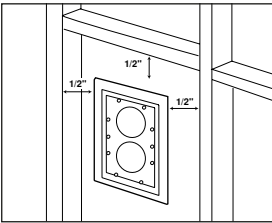

**Note:** Always allow at least one-half inch between a wall stud and the speaker cutout, or the locking tabs will not be able to swivel into place.

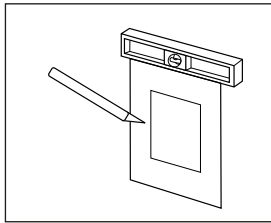

Cut the drywall.

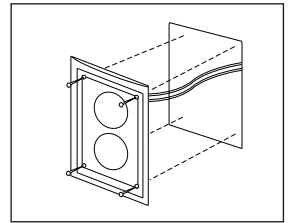

Connect the speaker wires to the speaker as described on pages 4–7.

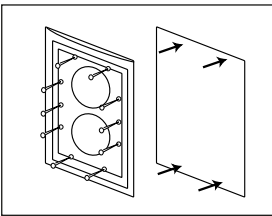

Place the frame assembly in the wall until the frame surface is flush with the wallboard.

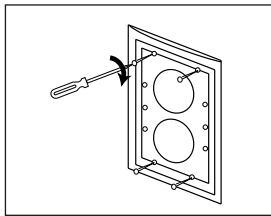

Screw down each of the ten Phillips-head screws. It is best to use a low-speed cordless driver or a hand-held screwdriver to tighten the screws to prevent over-tightening. The locking tabs will swivel into place and secure the unit to the rear surface of the drywall.

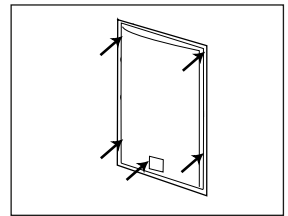

Replace the metal grille. Attach the JBL logo to the grille to correspond to vertical or horizontal installation.



## NEW CONSTRUCTION

You may either purchase the optional HT188 back box kit, or you may install the speaker after the wallboard has been installed by following the instructions for existing construction on page 8.

### INSTRUCTIONS FOR INSTALLING THE HT188 USING THE HT188BB BACK BOX KIT

The HT188BB enclosure ("back box") is optional. If desired, it is installed during new construction before the wallboard is installed.

#### Included With the HT188BB:

- (4) L-brackets
- (8) #10 32 x 1" screws
- (8) #10 split washers
- (8) #10 flat washers
- (8) #8 x 3/4" woofer screws
- (2) wood centering bars
- (4) #10 32 x 1-1/2" flat-head screws

#### Installation:

1. Install the two centering bars as shown in Detail B in the drawings. The centering bars are for setting the depth of the enclosure. They also help locate the left/right position of the enclosure as they can be mounted into the studs at the left and right to hold the enclosure in the correct location before final mounting.
2. Install the four L-brackets to the four corners of the enclosure. Each of the eight screws should have both the split washer and flat washer installed; the split washer goes on first. Leave the screws a half-turn loose at first to allow for adjustment later (see Detail A). Do not screw the L-brackets to the wall studs at this time (see step 6).

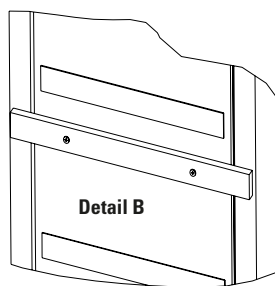
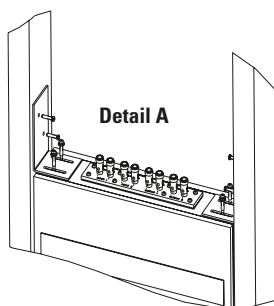
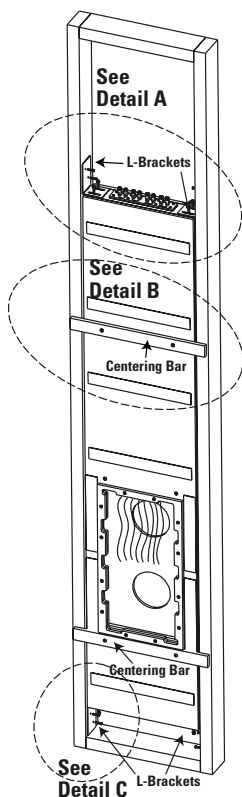

3. Fit the enclosure into the wall. The bottom edge of the bottom L-brackets will rest against the baseboard 2 x 4. At this time, make note of adjustments necessary to square the enclosure into the wall (see Detail C).

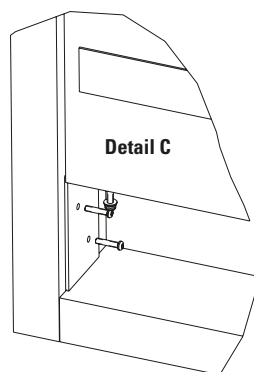

4. After refitting and tightening the L-brackets into the enclosure (but not the wall studs yet), fit the enclosure into the wall once again.
5. At this time, you may want to screw through each side of the wood centering bars to mount the enclosure to the studs. This will help hold the enclosure in position before the L-brackets are mounted to the studs.

6. Screw the L-brackets into the studs.
7. Remove the wood centering bars and replace the flat-head screws into the holes left over (the holes left in the cabinet face underneath the bars are also counterbored to accept the flat-head screws).
8. The enclosure is now installed and ready for the wallboard to be installed over it.
9. Make the connections from your receiver/amplifier to the HT188 back box connections panel, and to any other speakers as appropriate for your system, following the instructions on pages 4–7. Connect the eight wires hanging from the bottom of the HT188BB back box to the correct terminals on the HT188 loudspeaker. See pages 6–7.

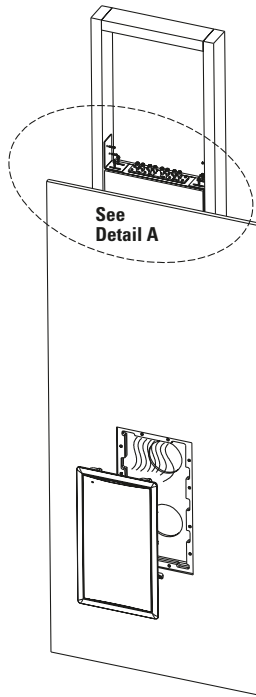

## PAINING THE SPEAKER FRAME AND GRILLE

JBL HTI Series loudspeakers can be painted to match any décor. If you wish to change their color, the satin finish on the grille and frame will function as a primer coat. Before painting, install the plastic paint shield securely into the recess in the baffle. This will protect the speaker components and baffle from paint residue.

Use a high-quality spray paint, and apply a thin coat of color. Paint the grille separately from the baffle before installing it.

**Be certain the grille perforations remain free of paint. Filling them with paint will diminish the sound quality.**

## TROUBLESHOOTING

### **If there is no sound from any of the speakers:**

- Check that receiver/amplifier is on and a source is playing.
- Check all wires and connections between receiver/amplifier and speakers. Make sure all wires are connected. Make sure none of the speaker wires are frayed, cut, punctured or touching each other.
- Review proper operation of your receiver/amplifier.

### **If there is no sound coming from one speaker:**

- Check the “Balance” control on your receiver/amplifier.
- Check all wires and connections between receiver/amplifier and speakers. Make sure all wires are connected. Make sure none of the speaker wires are frayed, cut, punctured or touching each other.

In multichannel applications, make sure that your receiver/processor has been configured to enable all channels that you are using.

### **If there is low (or no) bass output:**

- Make sure the connections to the “Speaker Inputs” have the correct polarity (+ and –). If you are using two HT188 subwoofers, try inverting the polarity on one subwoofer as described on page 4.
- Consider adding a separate power amplifier to drive the HT188 subwoofer.
- In Dolby\* Digital or DTS® modes, make sure your receiver/processor is correctly configured. When using a power amplifier with your HT188 subwoofer, make sure the subwoofer output of the receiver/processor has been enabled. See your receiver/processor’s owner’s manual for further information on correct speaker configuration in Dolby Digital, DTS and other surround sound modes.

### **If the system plays at low volumes but shuts off as volume is increased:**

- Check all wires and connections between receiver/amplifier and speakers. Make sure all wires are connected. Make sure none of the speaker wires are frayed, cut, punctured or touching each other.
- If more than one pair of main speakers is being used, check the minimum-impedance requirements of your receiver/amplifier.

# SPECIFICATIONS

## HTI88

<b>Frequency Response</b>	30Hz – 100Hz (–6dB)
<b>Maximum Recommended Amplifier Power †</b>	250 Watts per channel
<b>Impedance</b>	8 Ohms nominal per woofer
<b>Sensitivity</b>	94dB (2.83V/1m), both woofers driven
<b>Crossover Frequency</b>	100Hz, 2nd order
<b>Woofer</b>	Dual 8" polymer-coated aluminum cones w/rubber surrounds
<b>Plate Size (W x H)</b>	290mm x 518mm (11-7/16" x 20-7/16")
<b>Mounting Cutout Size (W x H)</b>	254mm x 465mm (10" x 18-5/16")
<b>Mounting Depth</b>	98mm (3-7/8")
<b>Weight per Speaker</b>	7.7kg (17 lb)

All features and specifications are subject to change without notice.

† The maximum recommended amplifier power rating will ensure proper system headroom to allow for occasional peaks. We do not recommend sustained operation at these maximum power levels.

\* Dolby is a registered trademark of Dolby Laboratories.

DTIS is a registered trademark of Digital Theater Systems, Inc.

Declaration of Conformity

**CE**

We, Harman Consumer Group International  
2, route de Tours  
72500 Chateau-du-Loir  
France

declare in own responsibility that the product described in this owner's manual is in compliance with technical standards:

EN 61000-6-3:2001  
EN 61000-6-1:2001

  
 Laurent Rault  
 Harman Consumer Group International  
 Chateau-du-Loir, France 4/05

<b>OWNER'S GUIDE</b>	<b>JBL</b>	<b>PRO SOUND COMES HOME™</b>
<b>PRODUCT LINE:</b> <b>JBL Home Theater In-Wall Series</b>	JBL Consumer Products - 250 Crossways Park Drive, Woodbury, NY 11797 - 516.255.4JBL (USA only) Europe: 2, Route de Tours, 72500 Château du Loir, France <a href="http://www.jbl.com">www.jbl.com</a>	
<b>MODEL: HTI88</b>	<b>NOTE:</b> For new-construction applications, be sure to purchase the HTI88BB back box kit.	
<b>DESIGN GOAL:</b> Combine the superior performance of traditional JBL loudspeakers with the convenience of in-wall installation.	© 2005 Harman International Industries, Incorporated. All rights reserved.	
<b>WOOFER TYPE:</b> Polymer-coated aluminum cone with rubber surround	JBL is a registered trademark of Harman International Industries, Incorporated.  Part No. 406-000-05223	
<b>CROSSOVER NETWORK:</b> Straight-Line Signal Path™ (SSP™)	<b>H</b> A Harman International Company	
<b>PROFESSIONAL REFERENCE:</b> Studio Monitor		